

## GETTING STARTED

### Basic Chaos Construction

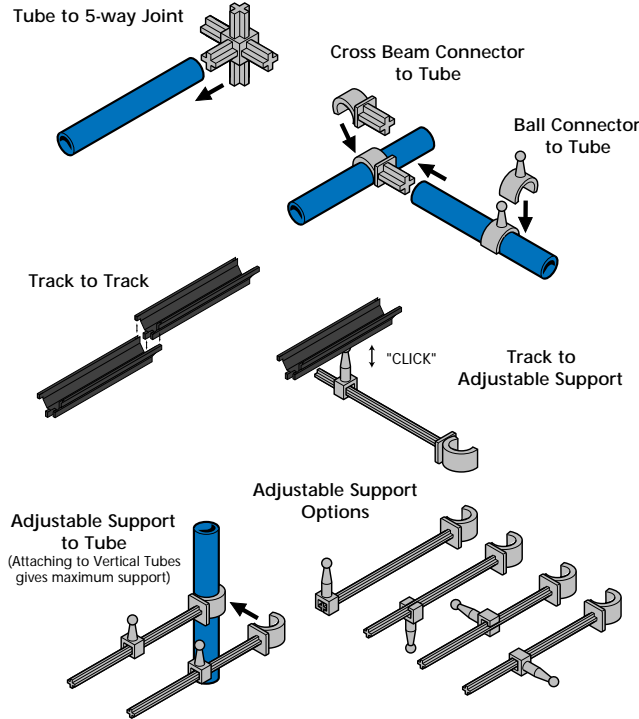

Try to keep 180° and 90° Curves level. This prevents the balls from flying off as they go around the curve. Change the slope in and out of the curve with Flex Track.

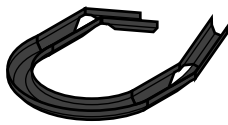

Level Track

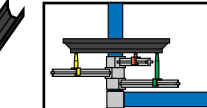

Mount two or three Adjustable Supports on top of each other on a vertical tube. Place a Short Clip on the top arm, a Medium Clip on the middle arm and a Tall Clip on the bottom arm. This creates level track.

Use a Ball Drop with a Paddle Switch or a Pendulum Switch to create alternate routes.



Change the slope and keep the ball rolling by adding Flex Track to both ends of the Paddle Switch

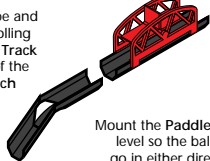

Mount the Paddle Switch level so the ball can go in either direction.

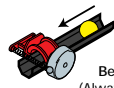

**Bell to Track**  
(Always mount the spring side of the Bell away from the direction the ball is going.)  
Besides being a noisemaker, the Bell can also be used as a Brake on steep grades.

## Typical Chaos Framework

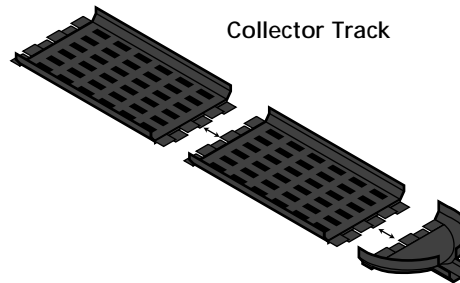
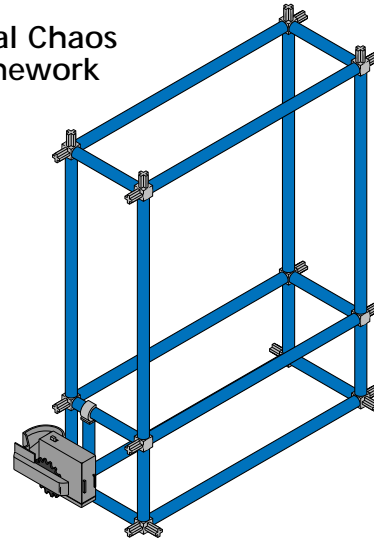

## Paddle Switch Assembly

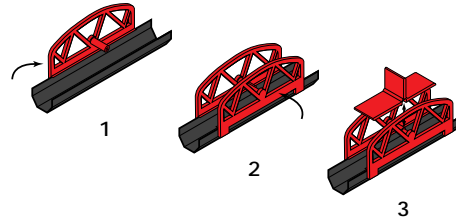

## Pendulum Switch Assembly

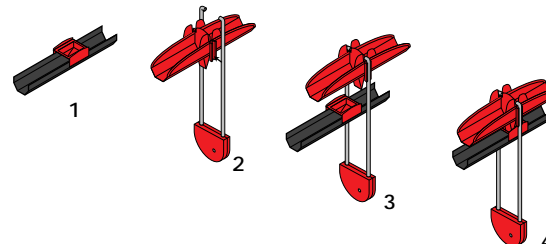

## SAFETY FIRST!

**CAUTION - ELECTRIC TOY: IMMERSING THIS TOY CAN CAUSE AN ELECTRIC SHOCK. NOT RECOMMENDED FOR CHILDREN UNDER EIGHT YEARS OF AGE. AS WITH ALL ELECTRIC PRODUCTS, PRECAUTIONS SHOULD BE OBSERVED DURING HANDLING AND USE TO PREVENT ELECTRIC SHOCK.**

INPUT: 120V AC 60Hz 5.4W OUTPUT: 4.5V DC 500mA INSTRUCTION BOOKLET INCLUDED

THIS PRODUCT IS LISTED BY UNDERWRITERS LABORATORIES INC. AND BEARS THIS MARK.



PATENT NO. 5,709,581

ITEM NO. 81002

**DANGER:** To prevent electric shock, do not immerse in water. Wipe clean with damp cloth.

**CAUTION:** Use in well ventilated areas.

**WARNING:** Shock Hazard. Unplug when not in use.

**CAUTION:** CONTAINS FUNCTIONAL SHARP POINTS, HANDLE WITH CARE!

**WARNING:** DO NOT USE ANY BALL IN THE CHAIN LIFT OTHER THAN A CHAOS BALL. Do NOT use marbles, ball bearings or anything other than Chaos balls.

**WARNING:** If you must clear a jam in the Chain Lift, turn off the motor and unplug it before attempting to clear the jam.

## CHAOS RULES

### HOW TO BUILD WITH CHAOS

1. Assemble Framework structure.
2. Assemble the Chain Drive, following ALL recommended construction hints.
3. Always build your track layouts from the top down.
4. The top views of the Track shown on the opposite side of this poster are shown in sequence from the top down.
5. All Chaos Turns are designed to be installed level. To change the slope of the track in and out of the turns use Flex-Track.
5. For maximum stability of the Loop-D-loop make sure you use the clips provided to hold the two halves together and to attach the track at either end.

## CONSTRUCTION HINTS

### CHAIN MOTOR AND LIFT ASSEMBLY

1. When assembling the chain, the open slots in each link should point away from the sprocket.
2. Snap the ball carriers in place after you have the chain completely assembled and attached to the sprockets.
3. When mounting the chain motor to the framework use the connector closest to the ball return. This will align the motor sprocket with the upper sprocket. The connector next to it can be used with one short tube and two cross beam connectors to provide additional support. (See Typical Chaos Framework above)
4. If you are building a tall vertical tower, assemble the the top half and the bottom half separately. When you have all the track and stunt pieces attached to each section, place the top half onto the bottom half. While building the top section, assemble the entire chain loop and hang it from the top sprocket assembly. (Remember the open slots in each chain link should point away from the sprocket.) After you have the top and bottom sections assembled, break the chain loop, thread it around the motor sprocket and reattach it. Have someone hold the loose end while you do this. Now you can snap the ball carriers in place at whatever intervals you desire.
5. DO NOT operate the Chain Motor on a rug or carpet. The Ball Carriers will catch on the fabric. On carpeted floors, place some type of smooth surface, such as a piece of cardboard or a magazine under the Chain Motor.